

**LTQ Orbitrap XL™
Hybrid FT Mass Spectrometer**

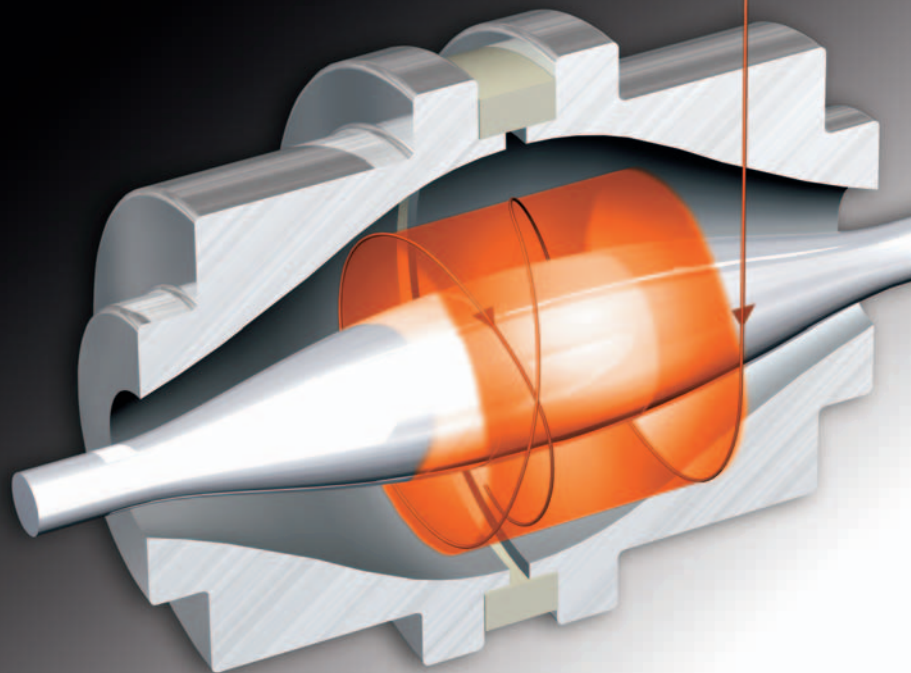

Unrivalled Performance and Flexibility

OFFERING OUTSTANDING MASS ACCURACY, RESOLVING POWER, DYNAMIC RANGE, AND HIGH SENSITIVITY

Based on the fast and highly sensitive Thermo Scientific LTO XL™ linear ion trap and the patented Orbitrap™ technology, the LTO Orbitrap XL hybrid FTMS (Fourier Transform Mass Spectrometer) supports a wide range of applications from routine compound identification to the most challenging analysis of low level components in complex mixtures.

LTQ ORBITRAP XL – UNRIVALED PERFORMANCE AND FLEXIBILITY

- Features the new HCD (Higher Energy Collisional Dissociation) collision cell for ultimate flexibility in fragmentation experiments for advanced proteomics and small molecule research
- Future upgrades will include ETD (Electron Transfer Dissociation) and MALDI capabilities



The LTO Orbitrap™ received the R&D 100 Award in 2006 and the PITTCON Editor's Gold Award at PITTCON 2006.



PRINCIPLE OF OPERATION

The hybrid FT mass spectrometer combines a linear ion trap MS and the Orbitrap mass analyzer. Ions generated by API are collected in the LTO XL followed by axial ejection to the C-shaped storage trap which is used to store and collisionally cool ions before injection into the orbital trap. The ions transferred from the C-Trap are captured in the orbital trap by rapidly increasing the electric field and the detection of the image current from coherent ion packets takes place after the voltages have stabilized. Signals from each of the orbital trap outer electrodes are amplified and transformed into a frequency spectrum by fast Fourier transformation which is finally converted into a mass spectrum.

Additionally, the LTO Orbitrap XL features a new collision cell to provide additional flexibility to any MS/MS experiment. Ions can be selected in the linear ion trap and fragmented either in the ion trap (CID) or in the new collision cell (HCD). For HCD (Higher Energy Collisional Dissociation) ions are passed through the C-trap into the gas-filled collision cell. Normalized Collision Energy in HCD MS/MS experiments provides reproducible data from instrument to instrument.

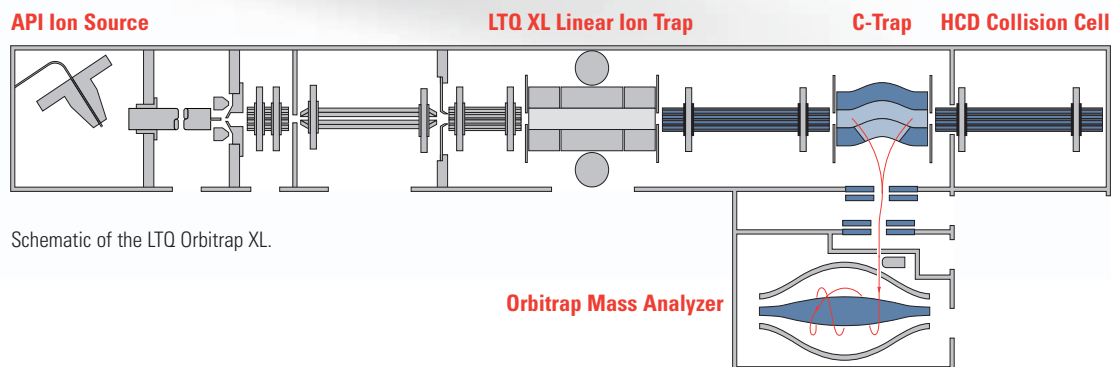

Schematic of the LTO Orbitrap XL.

THE MOST CONFIDENT PROTEIN IDENTIFICATION

The analysis of complex protein mixtures is one of the most challenging tasks in the area of proteomics. The key requirements of mass spectrometry based methods are a wide dynamic range, outstanding mass accuracy, fast cycle times for MS/MS experiments, and high sensitivity. The LTQ Orbitrap XL meets all of these requirements and provides the most confident protein identification.

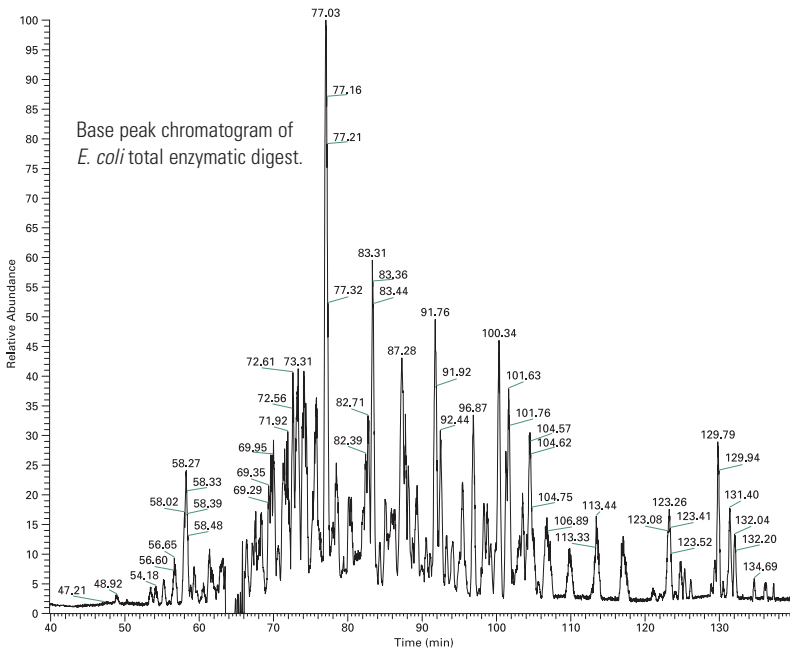

THE LTQ ORBITRAP XL PROVIDES:

- Superior mass accuracy for lower false positive rates
- High sensitivity and dynamic range leading to more protein ID
- Parallel acquisition mode for optimized productivity
- Excellent MS/MS sensitivity

Comparison of the protein identification results (MASCOT) between the LTQ Orbitrap XL and latest Q-TOF technology.

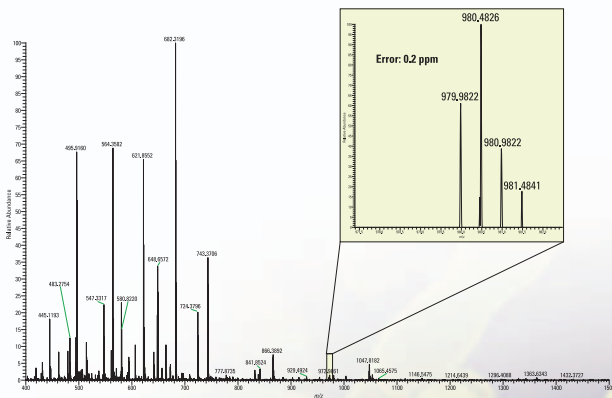
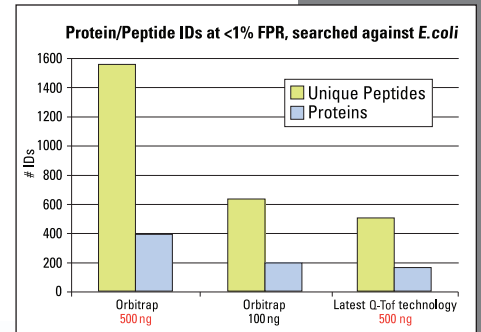

Orbitrap mass analyzer full scan MS at RT 89.4 min with zoom-in.

Experimental Method

- *E. coli* total digest (500 ng)
- Online nano LC-MS and MS/MS
- Optimized productivity with parallel detection
- Orbitrap mass analyzer full scan with Ion Trap Top 7 Data Dependent™ MS/MS
- Dynamic exclusion

BioWorks™ result of the database search showing the confident peptide identification.

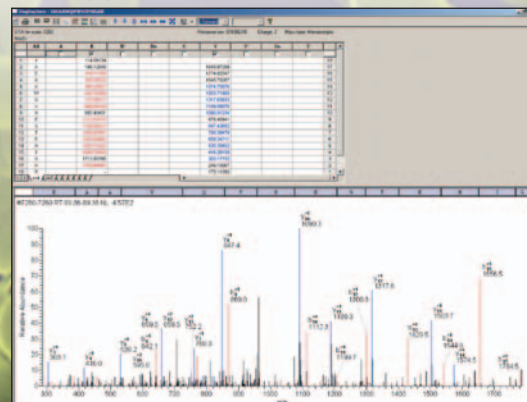

FROM PROTEIN ID TO BIOMARKER DISCOVERY

An important aspect of proteomics is not only the identification of all proteins in complex biological samples but also the accurate determination of their relative concentrations. Several analytical approaches to protein quantitation have been developed, including isotopic labeling techniques such as iTRAQ™. This method relies on the measurement of specific reporter ions in the low m/z region of MS/MS spectra of target peptides. The new HCD collision cell of the LTQ Orbitrap XL is ideally suited to perform such experiments with excellent sensitivity and signal-to-noise ratio (S/N) for the reporter ions and the fragment ions of the peptide sequence.

THE LTQ ORBITRAP XL WITH NEW HCD COLLISION CELL PROVIDES:

- Excellent sensitivity and fragmentation efficiency
- Reliable identification and quantitation in one experiment
- More confidence in biomarker research

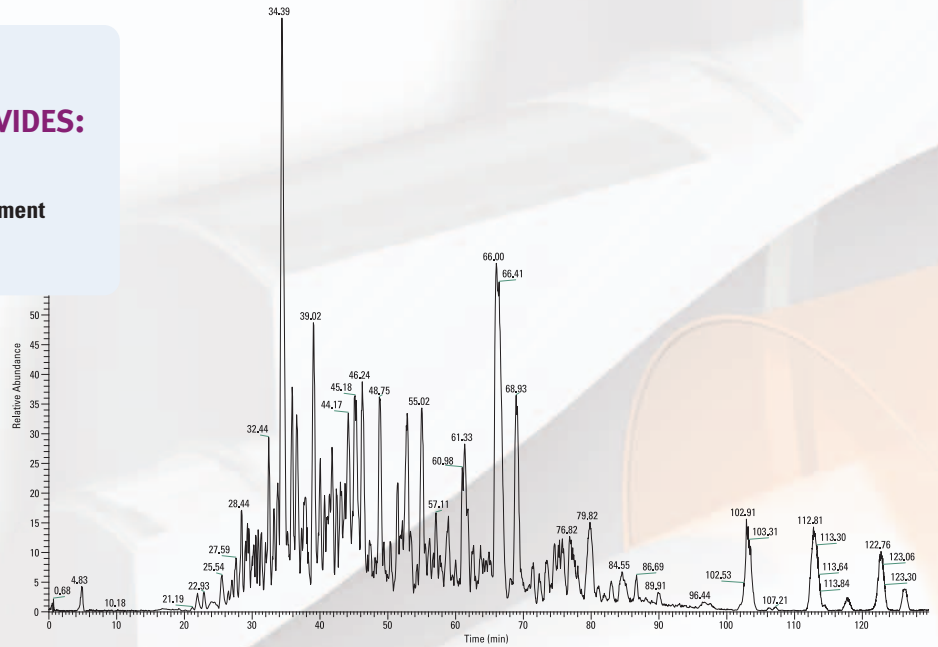

Base peak chromatogram of nano LC-MS and MS/MS analysis.*

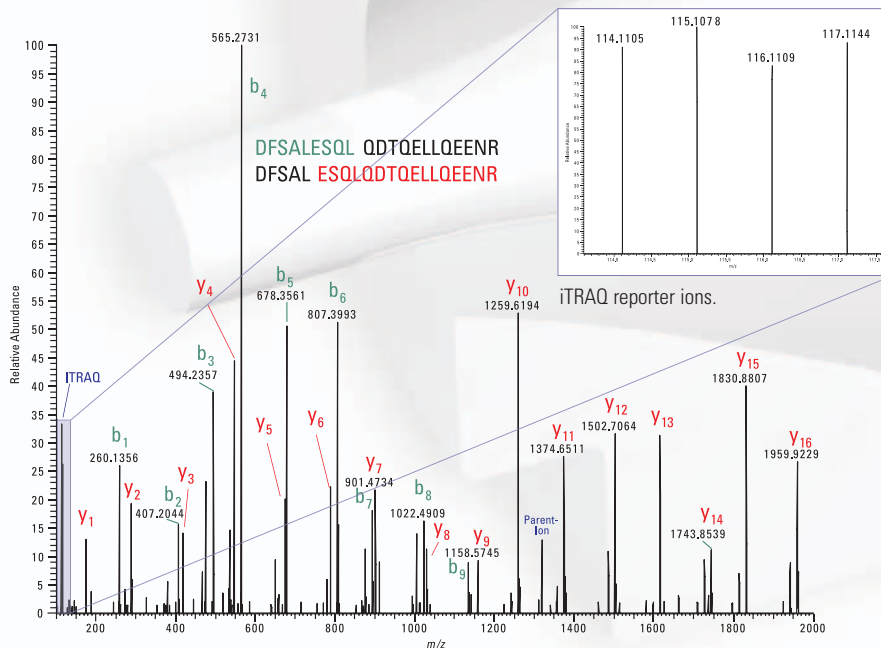

HCD spectrum for FSALESQLQDTQELLQEENR (MYH9_MOUSE, Myosin-9) in mouse cell line digest derivatized with four iTRAQ reagents.*

Experimental Method

- Mouse cell line
- iTRAQ labeled
- Online nano LC-MS and MS/MS
- Orbitrap mass analyzer full scan at R = 30,000
- Data Dependent Top 3 MS/MS using HCD
- Dynamic exclusion

* The isotopically labeled (iTRAQ) protein digest sample was provided by Jarrod Marto, Ph.D. and Yi Zhang, Ph.D., BLAIS Proteomics Center Boston, MA USA

HIGH QUALITY DATA FOR RELIABLE *DE NOVO* SEQUENCING

While the extensive use of large-scale genomic sequencing has greatly simplified the task of identifying peptides and proteins by mass spectrometry, the use of *de novo* sequencing is still required in proteomics research.

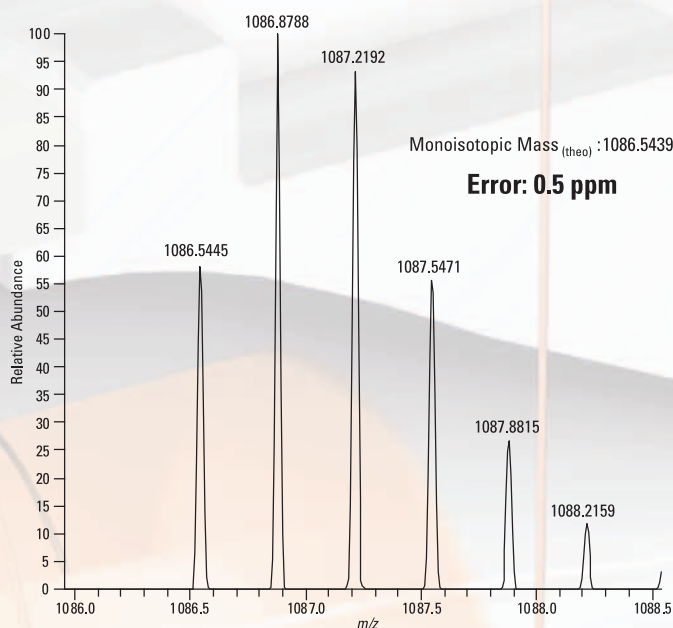

Spectrum of precursor ion with excellent mass accuracy.

BASED ON ULTIMATE PERFORMANCE THE LTQ ORBITRAP XL PROVIDES:

- Superior mass accuracy and high resolution leading to confident *de novo* sequencing results
- Multiple collision modes (CID and HCD) for comprehensive structural information

Experimental Method

- Enzymatic enolase digest
- Online nano LC-MS and MS/MS
- Orbitrap mass analyzer full scan at R = 60,000
- Data Dependent Top 3 MS/MS using HCD
- Dynamic exclusion

Zoom-in on low mass range showing detected immonium ions.

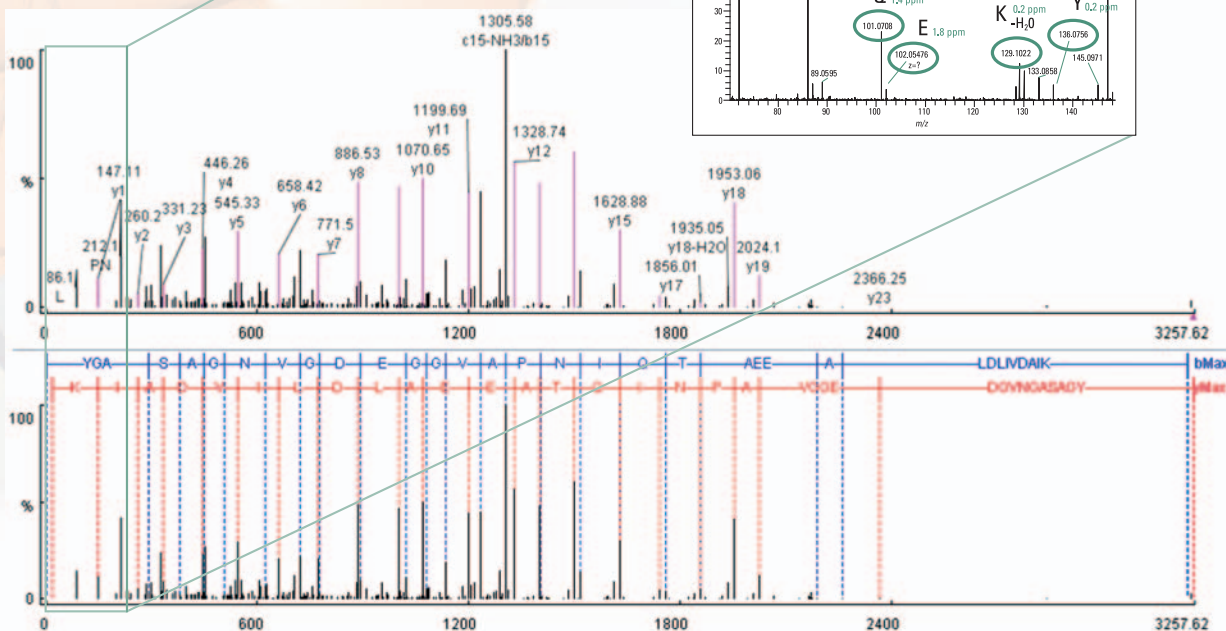
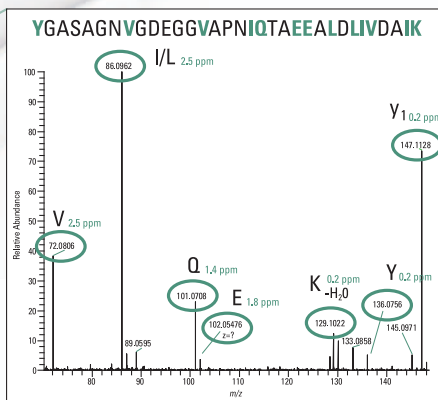

CONFIDENT METABOLITE PROFILING AND IDENTIFICATION

The characterization of metabolites plays an important role in drug development. Studies performed *in vivo* and *in vitro* lead to very complex mixtures containing the biological matrix background, the parent drug and all of the metabolites over a wide concentration range. Based on the selectivity, sensitivity, and speed of analysis, liquid chromatography tandem mass spectrometry has become the method of choice for metabolite profiling and identification.

BASED ON ULTIMATE PERFORMANCE THE LTQ ORBITRAP XL PROVIDES:

- Automated workflows using MetWorks™ and Mass Frontier™ for structural elucidation
- Reliable metabolite profiling and identification based on accurate mass
- Improved confidence by MSⁿ spectral tree fingerprints to distinguish even isobaric compounds

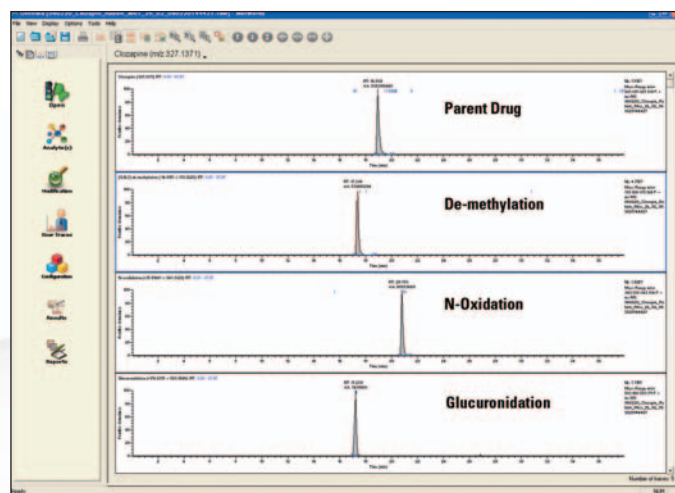

Automated identification of expected metabolites based on accurate mass using MetWorks.

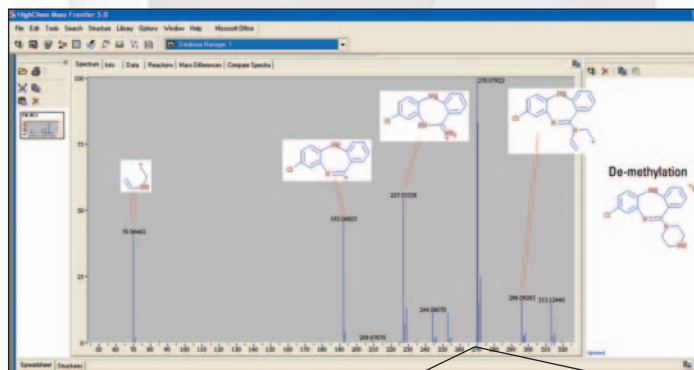

Structural elucidation based on the unique MSⁿ capability of the LTQ Orbitrap XL.

Clozapine
C₁₈H₁₉N₄Cl
[M+H]⁺ 327.1371

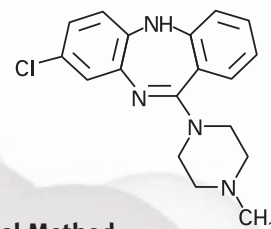

Experimental Method

- Clozapine *in vitro* incubation
- Online LC-MS and MSⁿ using CID and HCD
- Orbitrap mass analyzer full scan
- Isotopic pattern triggered MS/MS
- Dynamic exclusion

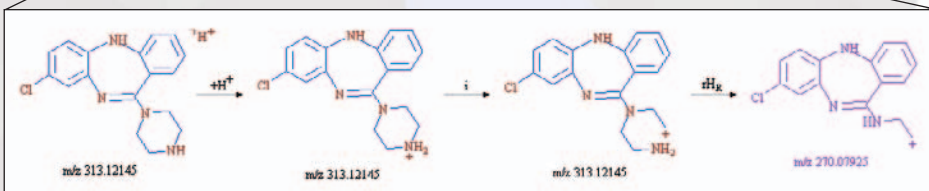

Proposed fragmentation pathway of m/z 270 according to Mass Frontier.

CONFIDENT CHARACTERIZATION OF METABOLOMIC PROFILES

The goals of metabolomics studies are to compare the abundance of the small molecule metabolites in highly complex matrices such as body fluids and tissues. The greatest challenges are the detection of low abundance metabolites amidst a vast background of unchanged metabolites and to confidently identify their structure.

THE LTQ ORBITRAP XL WITH NEW HCD COLLISION CELL PROVIDES:

- Outstanding mass accuracy, sensitivity, and dynamic range for metabolic profiling
- Confident determination of the identity and structure of metabolites
- Determination of differentially expressed metabolites using SIEVE™ in conjunction with Mass Frontier

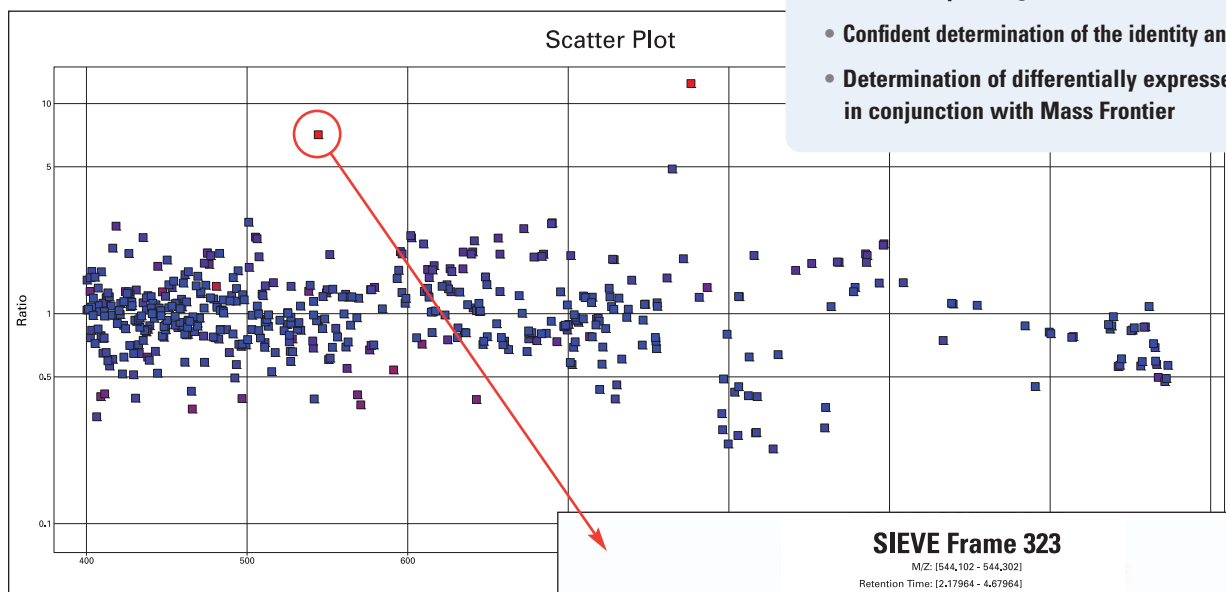

2-Dimensional scatter plot showing over- and under-expression generated by Spotfire.

Experimental Design

- *In vivo* drug treatment of rats
- Controls: untreated day one rat urine
- Samples: drug treated day one rat urine
- Orbitrap mass analyzer full scan
- SIEVE and Spotfire® used to display metabolites that demonstrate statistically significant differences

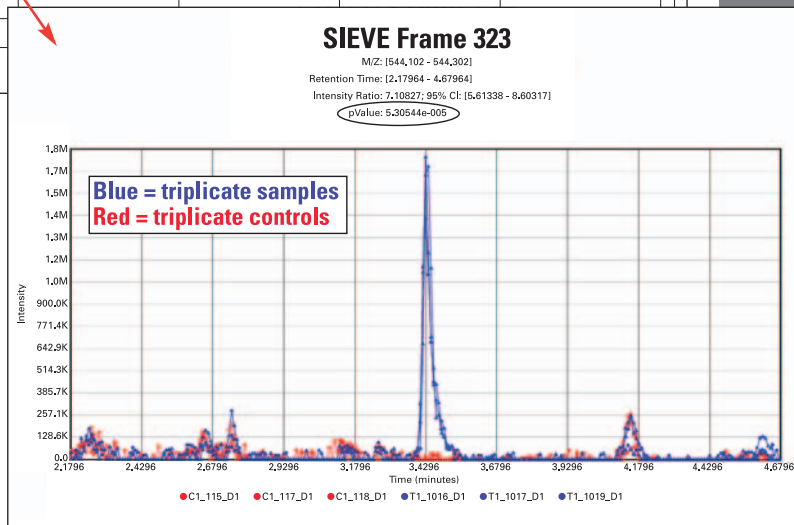

Zoom into SIEVE frame

Detailed information of over-expressed metabolites.

FrameID	MZStart	MZStop	TimeStart	TimeStop	pValue	Ratio	UpperBound	LowerBound	Events	Intensity_C1_115_D1	Intensity_C1_117_D1	Intensity_C1_118_D1	Intensity_T1_1016_D1	Intensity_T1_1017_D1	Intensity_T1_1019_D1
323	544.1021	544.3021	2.18	4.68	5.31E-005	7.108	8.603	5.613	9	210135.1848	265482.0675	207255.5073	1762682.37	1395045.924	1698423.379
169	776.2076	776.4076	2.19	4.69	1.40E-004	12.466	16.783	8.149	9	248036.04	177268.4404	166856.2617	3017460.379	2419813.808	1946363.542
127	480.6656	480.8656	0.71	3.21	6.01E-004	1.349	1.430	1.269	23	2546329.35	2599185.387	2729147.611	3577011.651	3389734.515	3658062.551

THERMO SCIENTIFIC APPLICATION-SPECIFIC SOFTWARE—TURNING DATA INTO INFORMATION

Xcalibur™ data system

Stable operating platform

Xcalibur is the versatile, easy-to-use data system that controls all Thermo Scientific MS systems. Xcalibur's Home Page offers easy navigation through the process of instrument setup, sequence setup, and data acquisition. The XReport reporting package simplifies custom reporting with drag-and-drop functionality.

ProteinCalculator

ProteinCalculator performs *in silico* digestion. Specify peptide sequences or import them from a fasta database, select post-translational modifications from a list or edit novel PTMs, then digest them with an enzyme of your choosing. The proteolytic fragment spectra can be saved as RAW data files for comparison with acquired spectra.

Xtract

Xtract deconvolutes isotopically resolved data, simplifying complex MS/MS spectra acquired in top-down, intact protein analysis. Specify the mass range, mass resolution, and S/N criteria for deconvolution and display in one of four modes: monoisotopic masses, isotopic pattern, or approved or disapproved signals. The results can be exported as RAW or ASCII file formats.

BioWorks protein identification software

Confident protein ID featuring the SEQUEST® algorithm

BioWorks utilizes the SEQUEST search algorithm to automatically identify proteins by comparing experimental tandem mass spectrometry (MS/MS) data with spectra created from standard protein and DNA databases.

MetWorks drug metabolism software

Simplify the interpretation of complex metabolism data

MetWorks simultaneously searches multiple modifications of one or more parent drugs and interprets simple to complex isotope patterns, or unexpected or low abundance metabolites.

Mass Frontier spectral elucidation software

Turning mass spectral data into results

Mass Frontier contains a state-of-the-art database and predictive fragmentation module which allows you to easily interrogate and assign the structure of your compounds.

SIEVE differential expression software

Analysis of differential expression based on comparison of LC-MSⁿ datasets

SIEVE software provides label-free, semi-quantitative differential expression analysis of proteins, peptides, or metabolites from the comparison of multiple LC-MS data sets. It is a statistically rigorous tool for analyzing data from metabolism or biomarker discovery experiments.

In addition to these offices, Thermo Fisher Scientific maintains a network of representative organizations throughout the world.

Australia

+61 2 8844 9500 • analyze.au@thermo.com

Austria

+43 1 333 50340 • analyze.at@thermo.com

Belgium

+32 2 482 30 30 • analyze.be@thermo.com

Canada

+1 800 532 4752 • analyze.ca@thermo.com

China

+86 10 5850 3588 • analyze.cn@thermo.com

Denmark

+45 70 23 62 60 • analyze.dk@thermo.com

France

+33 1 60 92 48 00 • analyze.fr@thermo.com

Germany

+49 6103 408 1014 • analyze.de@thermo.com

India

+91 22 6742 9434 • analyze.in@thermo.com

Italy

+39 02 950 591 • analyze.it@thermo.com

Japan

+81 45 453 9100 • analyze.jp@thermo.com

Latin America

+1 608 276 5659 • analyze.la@thermo.com

Netherlands

+31 76 587 98 88 • analyze.nl@thermo.com

South Africa

+27 11 570 1840 • analyze.sa@thermo.com

Spain

+34 91 657 4930 • analyze.es@thermo.com

Sweden / Norway / Finland

+46 8 556 468 00 • analyze.se@thermo.com

Switzerland

+41 61 48784 00 • analyze.ch@thermo.com

UK

+44 1442 233555 • analyze.uk@thermo.com

USA

+1 800 532 4752 • analyze.us@thermo.com

www.thermo.com

Installation Requirements

Power

230 Vac ±10% 3 phase, 16 Amps, 50/60 Hz, with earth ground for the instrument

120 or 230 Vac single phase with earth ground for the data system

120 or 230 Vac single phase, 15 Amps, with earth ground for the water chiller

Gas

One high purity (99.5% pure, flow rate 15 L/min) nitrogen gas supply for the API source

One ultra high-purity helium gas supply (99.998%) with less than 1 ppm each of water, oxygen, and total hydrocarbons for the linear ion trap

Environment

System averages 2800 W (10,000 Btu/hr) output when considering air conditioning needs

Operating environment must be 15-26 °C (59-78 °F) and relative humidity must be 40-70% with no condensation

Optimum operating temperature is 18-21 °C (65-70 °F)

Weight

~600 kg

Dimensions

141.4 × 87 × 146.3 cm
(H × W × D)

©2016 Thermo Fisher Scientific Inc. All rights reserved. iTRAQ is a trademark of Applied Biosystems. Mass Frontier is a trademark of HighChem, Ltd. PEAKS is a trademark of Bioinformatics Solutions, Inc. Spotfire is a registered trademark of Spotfire, Inc. SEQUEST is a registered trademark of the University of Washington. All other trademarks are the property of Thermo Fisher Scientific Inc. and its subsidiaries.

Specifications, terms and pricing are subject to change. Not all products are available in all countries. Please consult your local sales representative for details.

BR30135_E 09/16M

Thermo
SCIENTIFIC